

Something happens—a signal peaks or falls—and you need to know. A limit alarm trip can trigger the response needed to maintain normal, and safe, operations.

A limit alarm trip monitors a process signal (such as one representing temperature, pressure, level or flow) and compares it against a preset limit. If the process signal moves to an undesirable high or low condition, the alarm activates a relay output to warn of trouble, provide on/off control or institute an emergency shutdown.

While limit alarm trips are best known as a sure way to activate a warning light, siren or bell when a process problem occurs, they are also called upon to do much more. In fact, today's highly flexible and versatile alarm trips can be found working in a wide range of applications, under an impressive list of pseudonyms. Here are just some:

Hard-Wired Alarm
Trip Alarm
On/Off Controller
Limit Switch
Trip Amplifier or Trip Amp
Range Alarm
Safety Shutdown
Level Controller
Safety Interlock
Redundant Shutdown
Temperature, Voltage or Current Alarm
High/Low Controller
High Integrity Switch
Emergency Shutdown
Current or Temperature Switch
Sensor Failure Monitor
Comparator
Temperature Averaging Alarm
Supervisory Alarm
Differential Alarm
Rate-of-Change Alarm
Shutdown Alarm
Failsafe Alarm
Fault Monitor
Failsafe Shutdown
Window Alarm

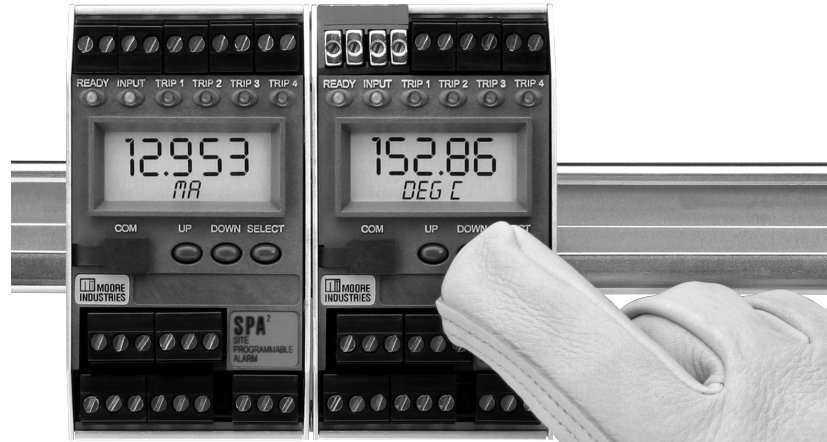

Independent “hard” alarm trips can be used to warn of trouble, provide on/off control or trigger an emergency shutdown.

“Hard” vs. “Soft” Alarms

Because they are hard-wired into the process and provide relay outputs, independent limit alarm trips are often referred to as “hard” alarms. This term differentiates a “hard” alarm trip from the software-implemented alarm (a “soft” alarm) which is found within a Distributed Control System (DCS) or a programmable logic controller (PLC).

Why Use “Hard” Alarms?

Most every plant performs alarm functions using “soft” alarms within their DCS or PLC. As such, some might argue that “hard” alarms are not necessary. However, “hard” alarm trips complement DCS and PLC systems by providing redundancy, simple control and critical safeguarding. Because of the potential consequences to

Figure 1. Limit alarm trips monitor a process signal and send one or more relay outputs when a monitored signal exceeds preset high and/or low limits (dual high/low alarm configuration shown).

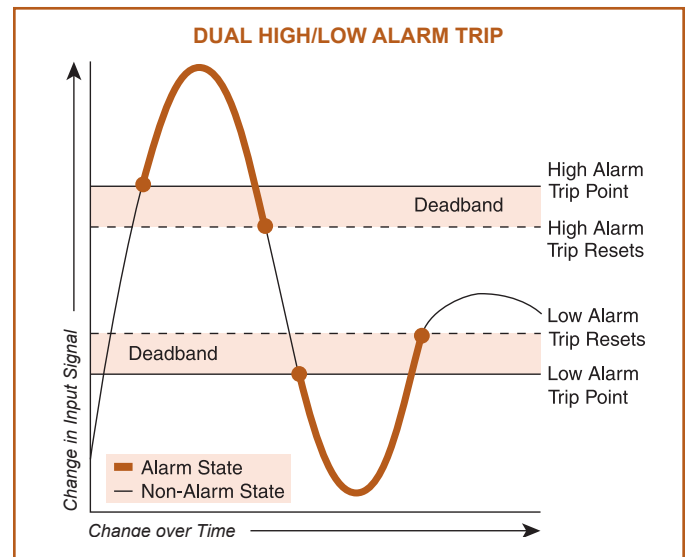

Alarm Trips: The Ups and Downs

Figure 2. “Hard” alarms are not exposed to the adverse effects of a common-mode failure because they maintain complete independence from the DCS or PLC system.

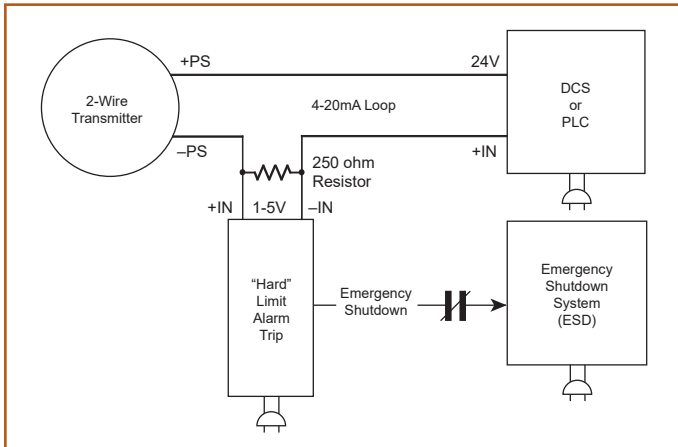

plant and personnel, “hard” alarm trips continue to be the accepted industry standard for a wide range of primary alarming functions, as well as for backup of DCS and PLC strategies in critical Emergency Shutdown (ESD) and Safety Related Systems (SRS).

“Soft” alarms can be susceptible to common-mode failures (such as failure of a computer-based system’s power supply, hardware or software) that could disable all of the “soft” alarms in the entire system. Therefore, “soft” alarms may be inappropriate for providing the degree of protection demanded for some critical applications, such as those found in Emergency Shutdown Systems (ESD) or Safety Instrumented Systems (SIS).

“Hard” alarms are not exposed to the adverse effects of a common-mode failure because they maintain complete independence from the DCS or PLC (Figure 2). “Hard” alarm trips distributed throughout a facility can be used to provide warnings and safety backup measures in the event of a common-mode failure. That’s why in critical and safety-related applications, the use of “hard” alarms is a requirement of many insurance companies.

Another good reason why “hard” alarms should be considered in place of, or to back up, “soft” alarms is that rather than intermittent scanning of individual points as is accomplished by a DCS or PLC, each “hard” alarm provides continuous supervision of an individual process signal. In some fast-changing applications, the computer’s scanning speed or network throughput time may be inadequate. In addition, “hard” alarms are typically easier to set up, which eliminates potential programming errors. They are also less prone to failure, inadvertent changes and tampering.

Worldwide Safety Adherence

Perhaps the most important role that “Hard” alarm trips play is their role in safety related applications.

Functional Safety

The process industry has seen dynamic growth in Functional Process Safety applications. Much of this growth has been driven by increased awareness of destruction of property, injuries and loss of life associated with tragic events that are widely publicized in the worldwide media. Companies have a moral and legal obligation to limit risk posed by their operations. In addition to their social responsibilities, the costs of litigation measuring in the billions of dollars has caught the eye of risk management executives worldwide.

That’s why companies are now actively taking steps to comply with various national and worldwide safety standards. To accomplish this, safety practitioners look to new generation equipment specifically designed and approved for use in Safety Instrumented Systems (SIS) that utilize Electrical and/or Electronic and/or Programmable (E/E/PE) technologies (Figure 3).

Figure 3. A typical Safety Instrumented System (SIS) is comprised of any number or combination of sensors, logic solvers and final control elements.

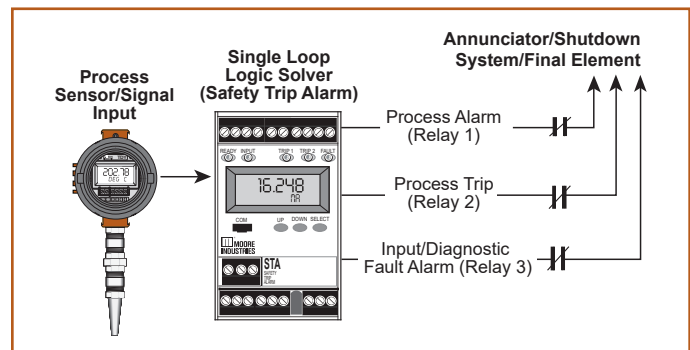

To help companies implement a SIS, the International Electrotechnical Commission (IEC) developed IEC 61508, the standard for “Functional Safety of Electrical/Electronic/Programmable Electronic Safety-Related Systems”.

The main objective of IEC 61508 is to provide a design standard for Safety Instrumented Systems to reduce risk to a tolerable level by following the overall hardware and software safety life cycle procedures, and by maintaining the associated stringent documentation.

IEC 61508 is the benchmark used mainly by safety equipment suppliers to show that their equipment is suitable for use in Safety Integrity Level (SIL) rated systems.

To learn more about Functional Safety and IEC 61508, request a copy of our **Functional Safety Wall Chart** or download our white paper titled **Safety Instrumented Systems: The “Logic” of Single Loop Logic Solvers**.

Alarms Trips: The Ups and Downs

Basic Limit Alarm Trip Functions

Anything from simple annunciation to shut down of an entire process can be handled by a limit alarm trip. An alarm trip accepts an input signal from a monitoring or control instrument, such as a signal transmitter or sensor. When the monitored variable falls outside of a user-set "Trip" (also called "Set") Point, the alarm trip activates one or more of its relay outputs. The relay(s) are typically used to control a warning light, annunciator, bell, pump, motor or a shutdown system.

In most units, once an alarm trips, it remains in an alarm condition until the process signal re-crosses the trip point and passes out of the deadband. An adjustable deadband makes it possible to increase or decrease this range, thus affecting what point the relay returns to its normal, non-alarm state.

Using this relatively simple "cause and effect" action, limit alarm trips can be economically used in a wide variety of basic and complex applications:

- Warn of trouble by providing a "hard" alarm output when a process signal exceeds a high and/or low limit.
- Create an independent emergency shutdown system to avert undesirable situations in the event of a central power failure or DCS shutdown.
- Provide redundant warning or shutdown capabilities to back-up and compensate for failure of DCS or PLC "soft" alarms.
- For simple applications, replace over-complicated PLCs with alarm trips that are easier to set up and use.
- Reliably and cost-effectively provide on/off control of pumps and motors in batching and similar applications.
- Sense dangerous conditions and shutdown control equipment before it is damaged.
- Monitor an input for a change in value, and trip an alarm when the input rate-of-change exceeds a selected rate, over a selected time period.

High and Low Limit Alarms

A high or low limit alarm is triggered when the value of the variable being measured exceeds a preset high or low alarm trip point (Figure 4). This type of alarm trip monitors temperature, pressure, level, flow, position or status variables, and is typically used to warn of unwanted process conditions or to provide emergency shutdown.

Figure 4. Dual high/low limit alarm trip with deadband to reduce relay chatter.

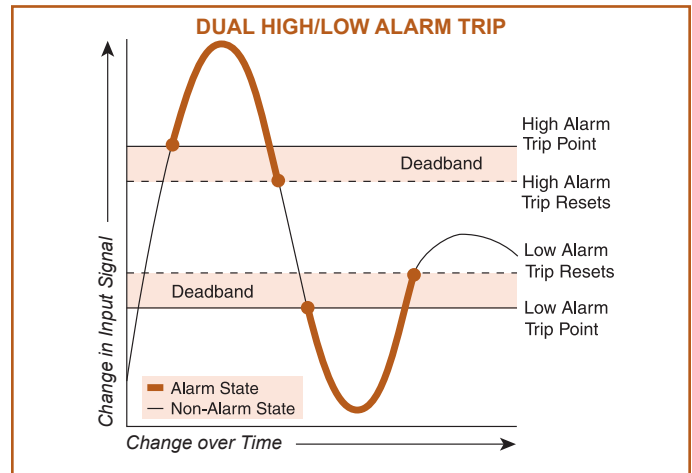

Alarm Trips with Multiple Relay Outputs

A limit alarm trip can have one, two or even four relay outputs. Typically, each relay output can be set to respond to a different trip point. This would include any combination of high or low alarm trips, with different trip point settings for each. Some alarm trips also offer the option of setting the relay to trip if there is an input fault (such as a broken sensor), or to alert that there is a problem with the alarm trip itself (Figure 5).

Figure 5. Multiple relay outputs allow one limit alarm trip to monitor combinations of high, low and input fault conditions.

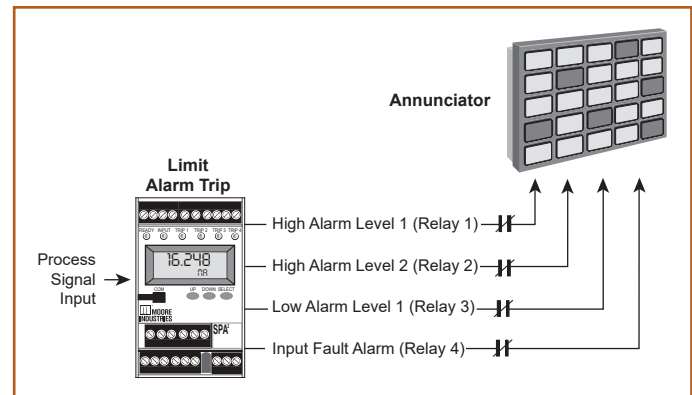

The following examples describe how alarm trip points might be set for a dual output limit alarm trip. Of course, if the alarm trip had four relay outputs, any combination of these same trip options could be applied to the remaining two relays.

High Alarm—A status change (alarm condition) of a single high alarm occurs when the input rises above the trip point. The status will return to a non-alarm condition when the input falls below the deadband.

High/High Alarm—This alarm accepts one input, but has two high relays, each with its own trip point. When the input rises above Trip Point 1 (the lower trip point), the first set of contacts will change status merely to

Alarm Trips: The Ups and Downs

serve as a warning; however, should the input rise above Trip Point 2 (the higher trip point), the second set of contacts change status, which may initiate an emergency shutdown. With four relay outputs, you can provide three levels of warning and then an emergency shutdown (Figure 6).

Figure 6. Alarm trips with multiple relays can be configured to provide various levels of protection such as Warning #1, Warning #2, Warning #3 and ultimately Emergency Shutdown.

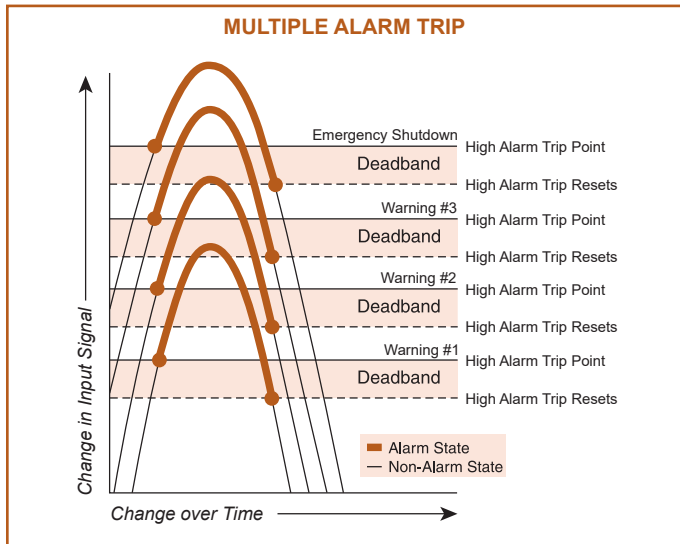

Low Alarm—A status change (alarm condition) of a single low alarm occurs when the input falls below the trip point. The status will return to a non-alarm condition when the input rises above the deadband. A typical application of a low alarm is warning of a low tank level to avert problems with a pump running dry.

Low/Low Alarm—A dual low alarm accepts one input, but has two relays, each with its own independent trip point. When the input falls below Trip Point 1, the first set of contacts will change status merely to serve as a warning. Should the input fall below Trip Point 2, the second set of contacts change status, possibly initiating a shutdown of the process. The low/low alarm's contacts will return to a non-alarm status when the signal rises above the lowest deadband. The low alarm's contacts return to a non-alarm status when the input signal rises above the higher alarm deadband. A typical application includes monitoring the low extreme temperature of a cryogenic tank to avoid over-cooling.

High/Low Alarm—A dual high/low alarm accepts one input and has two relays, each with a separate trip point (Figure 4).

Rate-of-Change Alarm

Used to detect changes in the measured value in units per minute or second, a rate of change alarm monitors an input for a change in value with respect to time (Figure 7). The alarm is set to trip when the input rate-of-change exceeds a user-selected rate (ΔT) over a user-selected time period (Δt).

Figure 7. Rate-of-Change alarm trip.

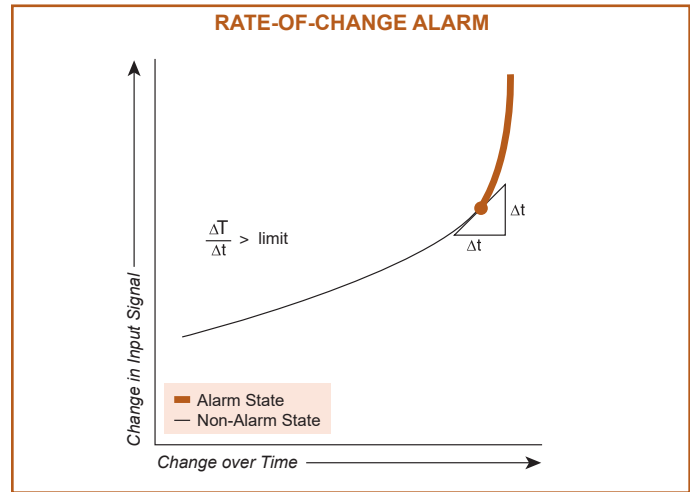

Input Fault Alarm

On some alarm trips, you can set one or more of the relays to trip when an input is interrupted, such as in the instance of a sensor break. This provides an alert of a non-critical sensor break without causing a costly false shutdown.

Self-Diagnostic Alarm

Some limit alarm trips continuously monitor their own status during operation, and trip if they are not operating properly.

Average and Differential Alarms

An average limit alarm trips when the average of two or three input signals exceeds a pre-selected high or low trip point (Figure 8). A differential alarm trips when the difference between two input signals, such as two RTD temperature sensors, exceeds a specific value.

Figure 8. Averaging Alarm Trip.

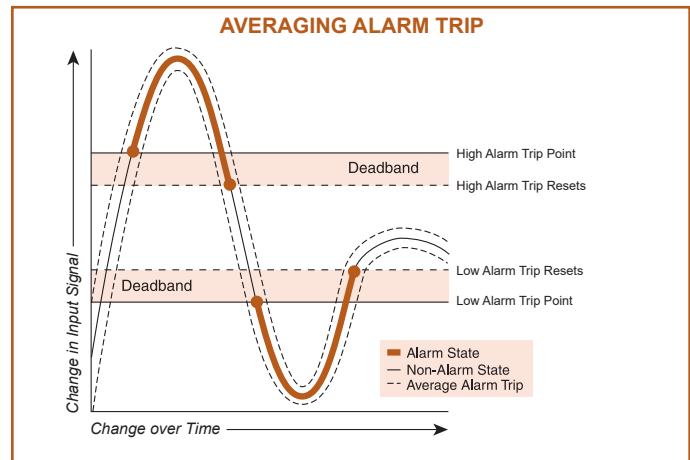

Window Alarm

The Window Alarm is activated when the process variable is outside of the low/high trip point ranges (Figure 9).

Alarms Trips: The Ups and Downs

Figure 9. Window Alarm.

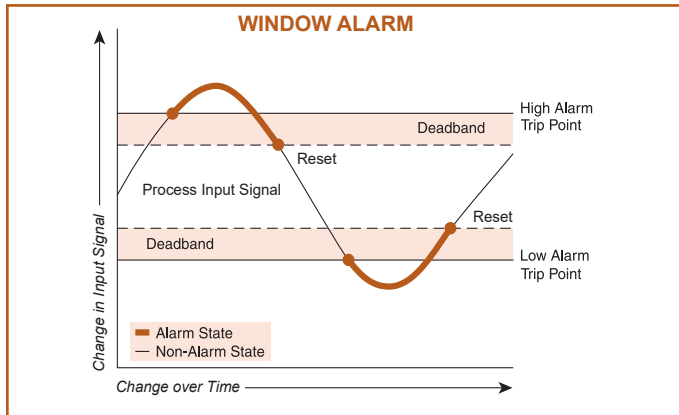

On/Off Control

A limit alarm trip can also be used as a simple on/off controller such as those required in level applications (pump/valve control) when filling or emptying a container or tank (Figure 10).

Figure 10. On/Off Control.

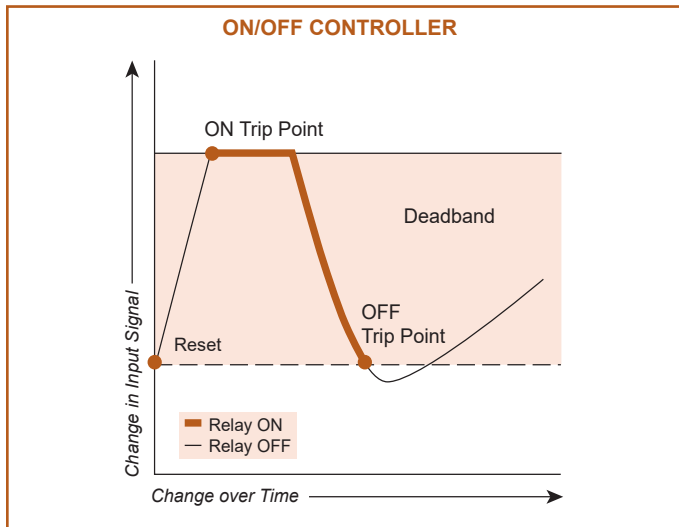

Alarm Trip Relay Responses

Normally Open and Normally Closed—Normal (or Normally) means the relay is in the de-energized (or shelf) state. When in the de-energized state, a Normally Open (NO) relay contact does not permit current to flow to the Common (C), resulting in an open circuit (Figure 11). When the relay is energized, there is a closed circuit between the NO and the C terminal. A Normally Closed (NC) relay contact allows current to flow to the Common (C) when the relay is in the Normal (de-energized) state (Figure 12). When the relay is energized, there is an open circuit between the NC and the C terminal (Figure 13).

There are three common types of alarm relay configurations: Single-Pole/Single-Throw; Single-Pole/Double-Throw; and Double-Pole/Double-Throw.

Single-Pole/Single-Throw (SPST)—A SPST has one pole (Figure 11). When the contact closes, it allows current to flow across the relay. If this relay is Normally Open (NO), current only flows when the contact trips (energized). If the contact is configured Normally Closed (NC), current will flow until the alarm trips (energizes). The choice of Normally Open (NO) or Normally Closed (NC) is typically selectable.

Figure 11. Single-Pole/Single-Throw (SPST) Relay shown with a normally-open (NO) contact in the de-energized (shelf) state.

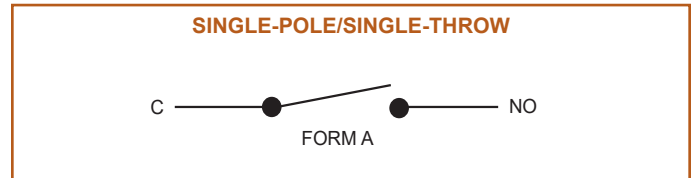

Single-Pole/Double-Throw (SPDT)—A SPDT contact has one pole and sends the electrical path in one of two directions (Figure 12). By providing both the NO and NC contacts, this type of relay can be quickly wired for any application.

Figure 12. Single-Pole/Double-Throw (SPDT) relay contacts are shown with the de-energized (shelf) state.

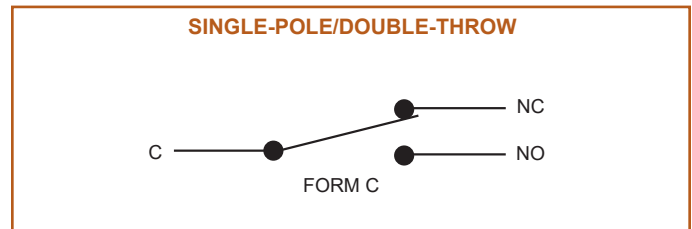

Double-Pole/Double-Throw (DPDT)—These give a single alarm trip two separate outputs from one relay (Figure 13). Both contacts on a DPDT change status at the same time. A DPDT relay make it possible for an alarm trip to perform two simultaneous functions. They are commonly used to annunciate and cause an action to occur, such as shutting off a valve or starting a blower.

Figure 13. Double-Pole/Double-Throw (DPDT) relay in the energized state.

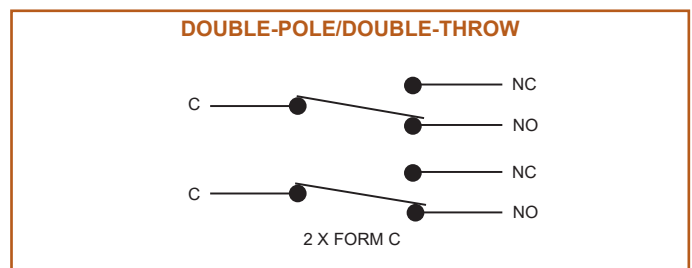

Failsafe and Non-Failsafe

Configuring an alarm trip as either failsafe and non-failsafe is a primary safety consideration. In a safety application, the foremost concern should be the alarm trip's action in the case of failure. An alarm trip with a

Alarm Trips: The Ups and Downs

relay that de-energizes if the input signal exceeds the trip point is called failsafe (Figure 17). This unit's relay is energized in the normal operating condition. As a result, should the power fail, this unit's relay operates as if it were in the alarm condition (Figure 14). Failsafe relay action is chosen for the vast majority of alarming applications.

Figure 14. Failsafe Relay Action upon power failure.

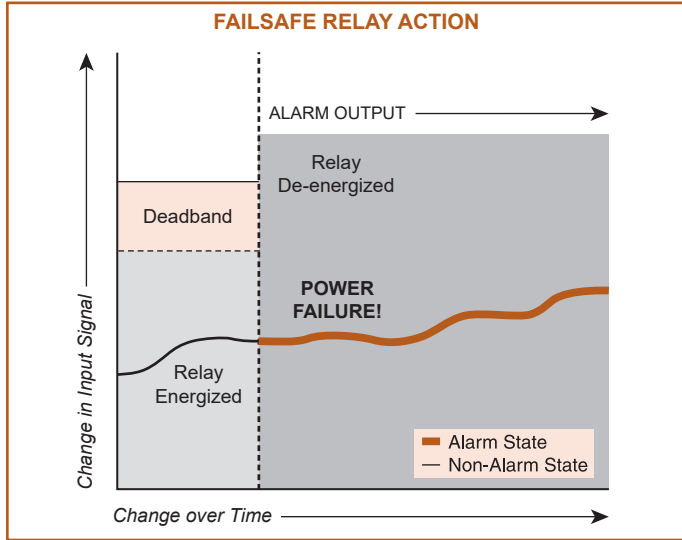

The other relay action is non-failsafe. This unit's relay is de-energized when the input signal is in the normal condition (Figure 16) and energized when an alarm occurs. In this configuration, the alarm trip will not provide a warning if there is a power failure (Figure 15). Should a loss of power and alarm condition coincide, the alarm would go undetected.

Figure 15. Non-Failsafe Relay Action upon power failure.

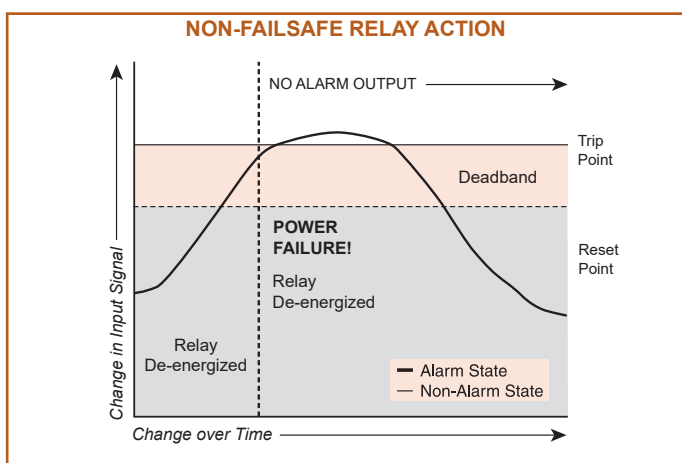

Normally Open/Normally Closed Combined with Failsafe/Non-Failsafe

The characteristics of Failsafe/Non-Failsafe and Normally Open/Normally Closed relay action can be integrated to provide specific alarming characteristics. To illustrate, consider an application where a light needs to be turned on when a high alarm trip point is reached.

Figure 16. A non-failsafe alarm is de-energized when in normal state (shown below) and energized when in alarm state.

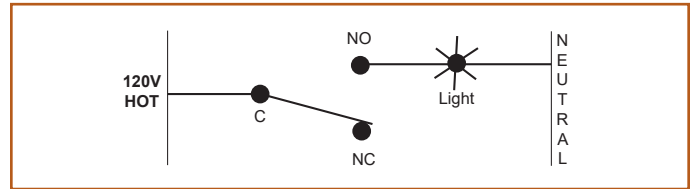

If the SPDT relay is non-failsafe, it is de-energized when in normal state (Figure 16), and energized when in alarm state. Therefore, when the trip point is exceeded, the relay energizes and sends the contact from NC to NO, turning on the light. Note that the light has to be wired to the NO side of the contact so that when the high trip occurs, the relay energizes and the circuit will close between the NO and C terminals.

Figure 17. A failsafe alarm trip is energized when it is not in the alarm state and de-energized when in alarm state (shown below).

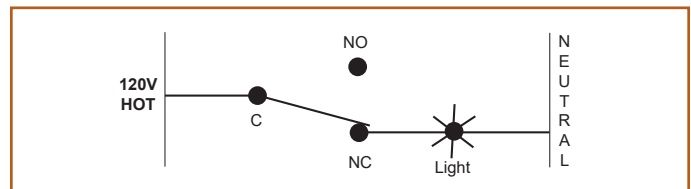

If the SPDT relay is failsafe, by definition it is energized when in normal state and de-energized when in alarm state. When the trip point is exceeded, the relay de-energizes and sends the contact from NO to NC (Figure 17), turning on the light by completing the circuit between the NC and C terminals. In this configuration, the light needs to be wired to the NC side of the contact. As stated earlier, this strategy is preferred because if power to the alarm trip is lost, an alarm is initiated to warn of trouble.

Deadband

The alarm trip fires its relay at the trip point and the relay resets when the process variable reaches the deadband point. Without deadband, if the process variable was hovering and cycling above or below the trip point, the relay would be chattering on and off, leading to premature failure. By setting the deadband just one or two percent away from the trip point, you can avoid excessive relay wear (Figure 18).

Latching vs. Non-Latching Alarms

A latching alarm is one where the relay cannot automatically reset. Once the relay trips, it remains in the alarm condition until an operator manually resets the relay (usually through a push button). Latching alarms are most commonly employed when you want to force an operator to acknowledge the alarm condition.

Alarms Trips: The Ups and Downs

Figure 18. Deadband reduces relay chatter.

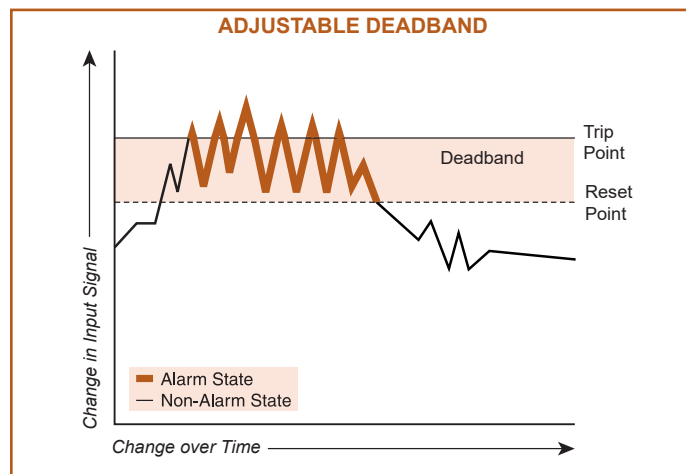

Contact Ratings and Precautions

The contact rating of relays used in alarm trips range from one to 10 amps. A typical annunciator requires only a one amp relay, while an electrical motor commonly requires a five amp relay. For an alarm trip to control a higher amperage device, such as a pump, an interposing relay can be used. To avoid needlessly damaging relays, two precautions must be taken. First, never operate a contact higher than its rating, even if it is momentarily. The rating of the alarms trip's relay should meet or exceed the device it controls to ensure reliable operations. Second, consider the implication of the load's behavior. Capacitive loads create inrush current at the startup which can damage a relay contact, while the arcing created by an inductive load can vaporize or weld shut a relay contact. Motor loads can have inrush currents five to six times normal run current.

Time Delay

In many applications a momentary over-range signal may not warrant an alarm trip. Some alarm trips can be set with an alarm response time delay that stops the alarm from going into an alarm condition unless the trip point has been exceeded for a specific time period (Figure 19). This can be used to stop false or premature alarms.

Figure 19. Alarm time delay stops false or premature alarms.

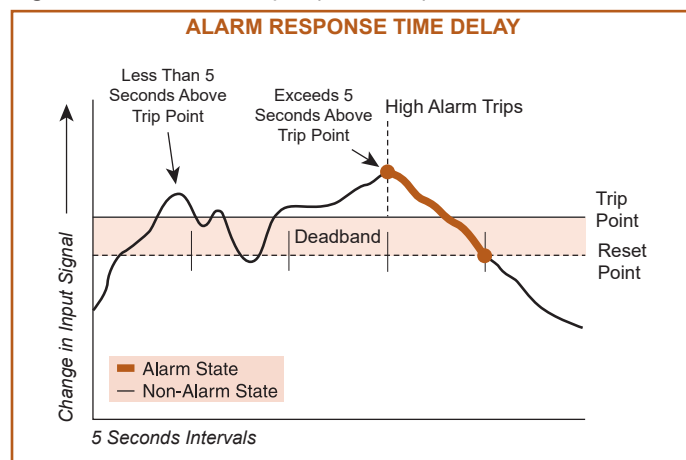

Transmitter Excitation

Some limit alarm trips offer the advantage of being able to provide 24Vdc power to a 2-wire (loop-powered) transmitter (Figure 20). This saves the cost of specifying and installing an additional instrument power supply.

Figure 20. Alarm trip providing 24Vdc power to the loop.

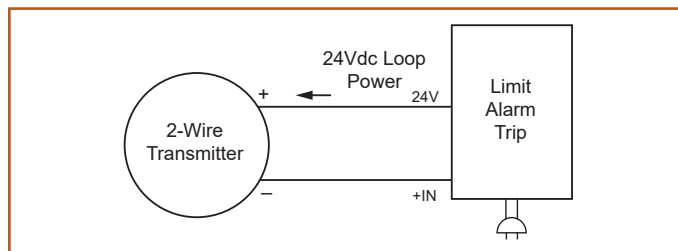

IS Associated Apparatus Alarm Trips

An IS system installation requires a separate barrier or associated apparatus interface between the field device and the control room equipment. It limits the energy to the hazardous area such that, even under a fault condition, there cannot be enough electrical or thermal energy released by the device to ignite an explosive atmosphere.

Zener Diode barriers are simple passive devices comprised of zener diodes, resistors and fuses that serve to limit the voltage, current, and power available to the hazardous area device. A common downside of using this approach is that the required earth ground has low noise rejection capability. This electrical interference can introduce stray and unwanted electrical noise components into the measurement circuit which can potentially create significant measurement errors.

Isolated barriers are active devices that incorporate galvanic isolation thus eliminating the requirement for an earth ground. These barriers require auxiliary operating power and cost more than passive zener barriers. The disadvantage of these separate IS barriers is the installation and maintenance costs. Many of these costs can be drastically reduced if an associated apparatus like the SPA²IS alarm trip is used. Since the associated apparatus includes the barrier in the receiving device there is no need for the additional cost of the barrier, cabinet space, a high integrity clean ground connection, separate power supply or custom vendor backplane.

Associated apparatus incorporate a barrier into the safe area (Class I, Div 2/Zone 2 or Unclassified) mounted receiving device or the control room equipment. The Moore Industries SPA²IS is an example of such a device that provides an isolating barrier within the alarm trip and that can be implemented in multiple configurations (Figure 21 and 22). This dramatically reduces the cost of purchase, installation and maintenance versus more traditional hazardous area alarming approaches that require a separate zener or isolating barrier installed in front of the alarm trip.

Alarm Trips: The Ups and Downs

Figure 21. An associated apparatus incorporating the isolating barrier, temperature transmitter, temperature alarm and diagnostic alarming functions in a single device.

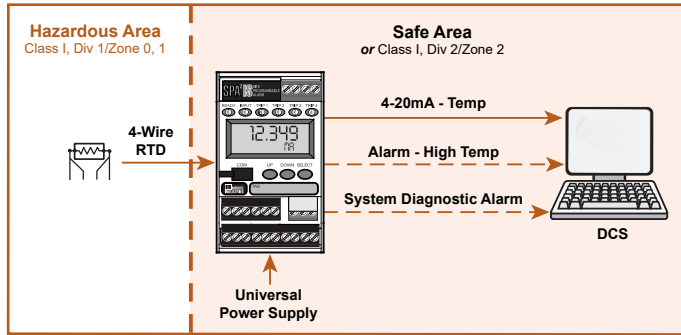
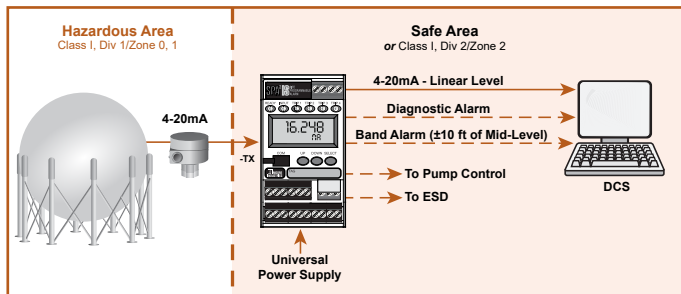

Figure 22. An associated apparatus incorporating a spherical tank linearization measurement function, local pump control, Hi-Hi ESD, local indication, self diagnostics and quad relay outputs for control and alarming.



To learn more about IS Associated Apparatus, see our white paper titled: **Associated Apparatus: The Safe and Most Affordable IS Solution.**

Redundant Architecture Avoids Nuisance Alarm Trips

Some processes are simply too important to rely on a single alarm trip to make a decision. For these, limit alarm trips can be used in a voting strategy.

Flare stacks are an example of a critical process used at refineries and gas processing plants. These stacks handle process upsets, surges and burn off volatile material before it is released into the atmosphere. If these flare stacks burn out it can cause a dangerous process situation, environmental upset or even cause an expensive plant shutdown. Due to the criticality of this process, three temperature sensors instead of just one are used in an array to determine whether the flare stack is active or not. To warn of flare stack burnout three alarm trips monitor the three temperature sensors and are wired in a 2oo3 (two out of three) voting scheme. If any two of the sensors indicate low temp, the flame out circuit is engaged (Figure 23). This redundancy reduces false trips and offers high process availability.

Figure 23. Alarm trips in a 2oo3 voting scheme.

